



iOS



Android



Monitoring platform



Jiangsu GoodWe Power Supply Technology Co.,Ltd

No.189 Kun Lun Shan Road, SND, Jiangsu, China.

www.goodwe.com

service@goodwe.com



ET SERIES USER MANUAL

HYBRID INVERTER

TABLE OF CONTENTS

01 INTRODUCTION

1.1 OPERATION MODES INTRODUCTION	01
1.2 SAFETY & WARNINGS	02
1.3 PRODUCT OVERVIEW	04

02 INSTALLATION INSTRUCTIONS

2.1 UNACCEPTABLE INSTALLATIONS	05
2.2 PACKING LIST	05
2.3 MOUNTING	06
2.3.1 SELECT MOUNTING LOCATION	06
2.3.2 MOUNTING	07
2.4 ELECTRICAL WIRING CONNECTION	08
2.4.1 PV CONNECTION	08
2.4.2 BATTERY CONNECTION	09
2.4.3 ON-GRID & BACK-UP CONNECTION	11
2.4.4 METER & CT CONNECTION	13
2.5 DRED & SMART EARTH FAULT ALARM	14
2.5.1 DRED CONNECTION	14
2.5.2 EARTH FAULT ALARM	14

03 MANUAL OPERATION

3.1 WI-FI CONFIGURATION & RELOAD	17
3.2 PV MASTER APP OPERATION WI-FI	18
3.3 CEI AUTO-TEST INSTRUCTION	18

04 OTHERS

4.1 ERROR MESSAGE AND TROUBLESHOOTING	19
4.2 DISCLAIMER	25
4.3 TECHNICAL PARAMETERS AND CERTIFICATES	26
4.4 WARNING QUICK CHECK LIST	28

01 INTRODUCTION

GoodWe ET series, also called hybrid or bidirectional solar inverters, apply to solar system with participation of PV, battery, loads and grid system for energy management. The energy produced by PV system shall be used to optimize self-consumption, excess power charge battery and the rest power could be exported to the grid. Battery shall discharge to support loads when PV power is insufficient to meet self-consumption. If battery power is not sufficient, the system will take power from grid to support loads.

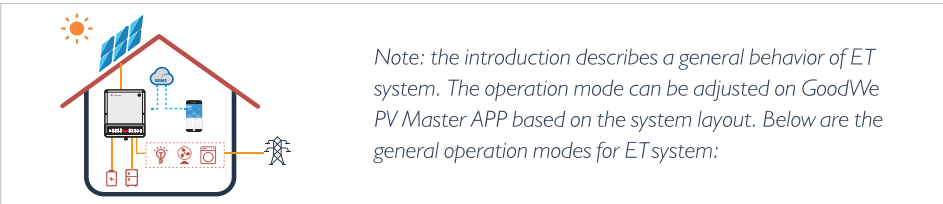

1.1 OPERATION MODES INTRODUCTION

ET system normally has the following operation modes based on your configuration and layout conditions

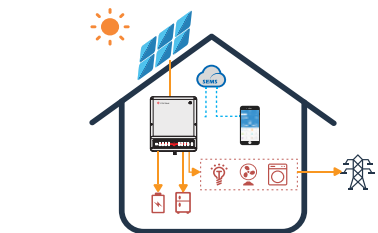

Mode I

The energy produced by the PV system is used to optimize self-consumption. The excess energy is used to charge the batteries, then exported to grid.

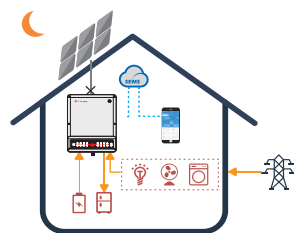

Mode II

When there is no PV, and the battery is sufficient, it can supply the load together with grid power.

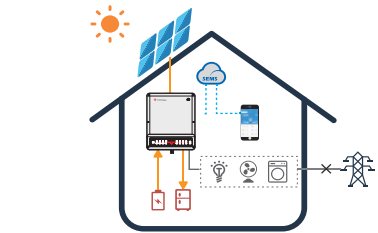

Mode III

When grid fails, the system automatically switches to Back-Up mode. The Back-Up load can be supported by PV and battery.

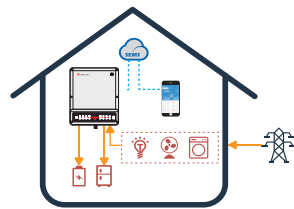

Mode IV

Battery can be charged by grid, and charging time/power can be set flexibly on PV Master APP.

1.2 SAFETY & WARNING

The ET series inverters of Jiangsu GoodWe Power Supply Technology Co., Ltd. (hereinafter called as GoodWe) strictly comply with related safety rules for product design and testing. Please read and follow all the instructions and cautions on the inverter or user manual during installation, operation or maintenance, as any improper operation might cause personal or property damage.

• SYMBOLS EXPLANATION



Caution!
Failing to observe a warning indicated in this manual may result in injury.



Danger of high voltage and electric shock!



Danger of hot surface!



Components of the product can be recycled.



This side up! The package must always be transported, handled and stored in such a way that the arrows always point upwards.



No more than six (6) identical packages being stacked on each other.



Product should not be disposed as household waste.



The package/product should be handled carefully and never be tipped over or slung.



Refer to the operating instructions.



Keep dry! The package/product must be protected from excessive humidity and must be stored under cover.



Inverter will be touchable or operable after minimum 5 minutes of being turned off or totally disconnected, in case of any electrical shock or injury.



CE Mark

• SAFETY WARNING

Any installation and operation on inverter must be performed by qualified electricians, in compliance with standards, wiring rules or requirements of local grid authorities or companies (like AS 4777 and AS/NZS 3000 in Australia).

Prohibit to insert or pull the AC and DC terminals when the inverter is running.

Before any wiring connection or electrical operation on inverter, all DC and AC power must be disconnected from inverter for at least 5 minutes to make sure inverter is totally isolated to avoid electric shock.

The temperature of inverter surface might exceed 60 °C during working, so please make sure it is cooled down before touching it, and make sure the inverter is untouchable for children.

Do not open inverter cover or change any components without GoodWe's authorization, otherwise the warranty commitment for the inverter will be invalid.

Usage and operation of the inverter must follow instructions in this user manual, otherwise the protection design might be useless and warranty for the inverter will be invalid.

Appropriate methods must be adopted to protect inverter from static damage. Any damage caused by static is not warranted by GoodWe.

PV negative (PV-) and battery negative(BAT-) on inverter side is not grounded as default design. Connecting PV- or BAT- to EARTH are strictly forbidden.

PV modules used on the inverter must have an IEC61730 class A rating, and the total open-circuit voltage of PV string/array is lower than the maximum rated DC input voltage of the inverter. Any damage caused by PV over-voltage is beyond warranty.

When exposed to sunlight, the PV array generates dangerous high DC voltage. Please operate according to our instructions, or it will result in danger to life.

The inverter, with built-in RCMU, will exclude possibility of DC residual current to 6mA, thus in the system an external RCD (type A) can be used.

In Australia, the inverter internal switching does not maintain neutral integrity, which must be addressed by external connection arrangements like in the Off-Grid System Connection Diagram in page 16.

In Australia, output of Back-Up side in switchbox should be labeled 'Main Switch UPS supply', the output of normal load side in switch box should be labeled 'Main Switch Inverter Supply'.

1.3 PRODUCT OVERVIEW

HYBRID LED INDICATORS		
INDICATOR	STATUS	EXPLANATION
SYSTEM		ON = SYSTEM IS READY
		BLINK = SYSTEM IS STARTING UP
		OFF = SYSTEM IS NOT OPERATING
BACK-UP		ON = BACKUP IS READY / POWER AVAILABLE
		OFF = BACKUP IS OFF / NO POWER AVAILABLE
		ON = BATTERY IS CHARGING
BATTERY		BLINK 1 = BATTERY IS DISCHARGING
		BLINK 2 = BATTERY IS LOW / SOC IS LOW
		OFF = BATTERY IS DISCONNECTED / NOT ACTIVE
GRID		ON = GRID IS ACTIVE AND CONNECTED
		BLINK = GRID IS ACTIVE BUT NOT CONNECTED
		OFF = GRID IS NOT ACTIVE
ENERGY		ON = CONSUMING ENERGY FROM GRID / BUYING
		BLINK 1 = SUPPLYING ENERGY TO GRID / ZEROSING
		BLINK 2 = SUPPLYING ENERGY TO GRID / SELLING
		OFF = GRID NOT CONNECTED OR SYSTEM NOT OPERATING
COM		ON=BMS AND METER COMMUNICATION OK
		BLINK1 = METER COMMUNICATION OK, BMS COMMUNICATION FAIL
		BLINK2 = BMS COMMUNICATION OK, METER COMMUNICATION FAIL
		OFF = BMS AND METER COMMUNICATION FAIL
WIFI		BLINK 1 = WIFI CONNECTED / ACTIVE
		BLINK 2 = WIFI SYSTEM RESETTING
		BLINK 3 = WIFI NOT CONNECT TO ROUTER
		BLINK 4 = WIFI SERVER PROBLEM
		OFF = WIFI NOT ACTIVE
		OFF = WIFI NOT ACTIVE
FAULT		ON = FAULT HAS OCCURRED
		BLINK = OVERLOAD OF BACKUP OUTPUT / REDUCE LOAD
		OFF = NO FAULT

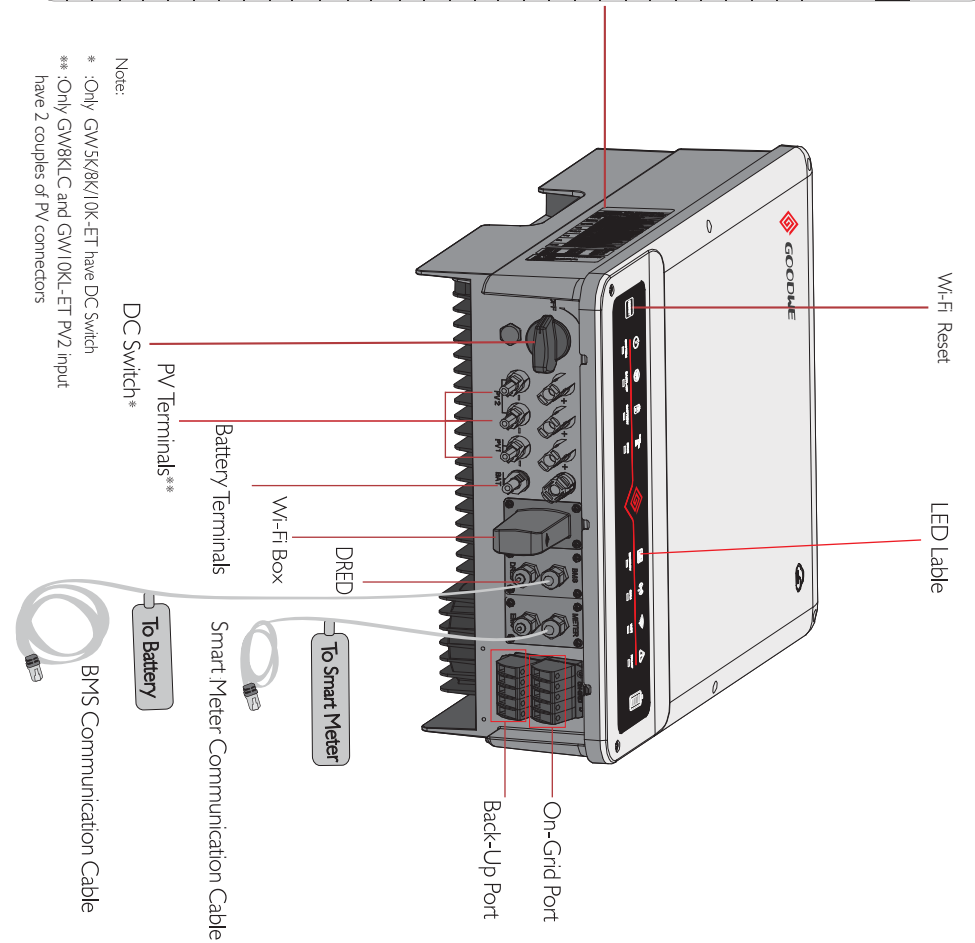

Note:
 * :Only GW5K/8K/10K-ET have DC Switch
 ** :Only GW8KLC and GW10KLC-ET PV2 input have 2 couples of PV connectors

02 **INSTALLATION INSTRUCTIONS**





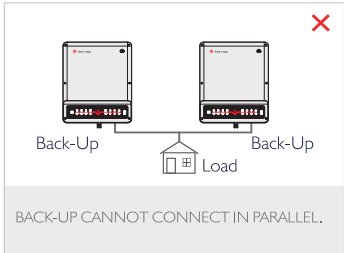
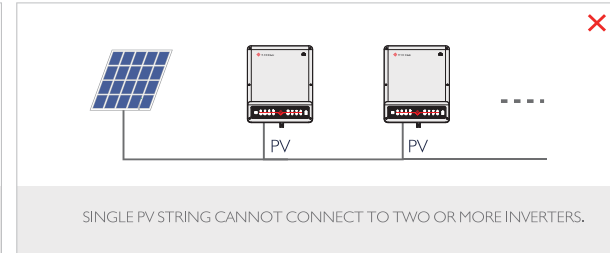
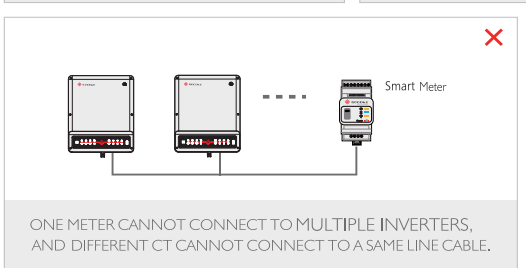
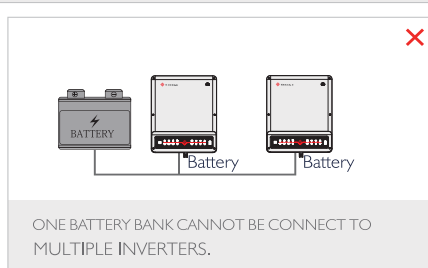
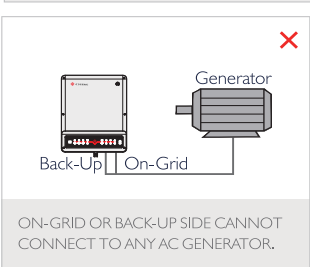
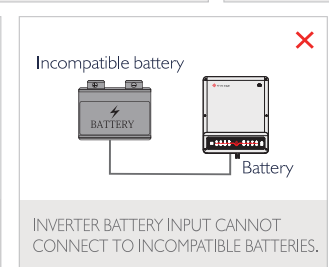
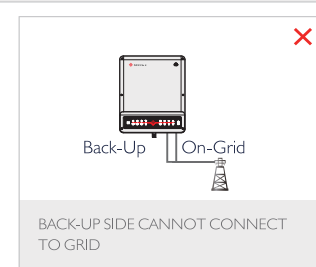



2.1 UNACCEPTABLE INSTALLATIONS

Please avoid the following installations, which will damage the system or the inverter.

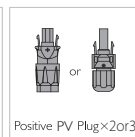
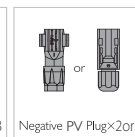
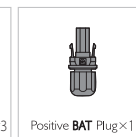
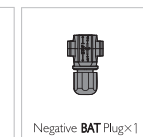
 <p>Back-Up Load Back-Up</p> <p>BACK-UP CANNOT CONNECT IN PARALLEL.</p>	 <p>PV PV</p> <p>SINGLE PV STRING CANNOT CONNECT TO TWO OR MORE INVERTERS.</p>	
 <p>Smart Meter</p> <p>ONE METER CANNOT CONNECT TO MULTIPLE INVERTERS, AND DIFFERENT CT CANNOT CONNECT TO A SAME LINE CABLE.</p>	 <p>BATTERY BATTERY</p> <p>ONE BATTERY BANK CANNOT BE CONNECT TO MULTIPLE INVERTERS.</p>	
 <p>Generator</p> <p>Back-Up On-Grid</p> <p>ON-GRID OR BACK-UP SIDE CANNOT CONNECT TO ANY AC GENERATOR.</p>	 <p>Incompatible battery</p> <p>BATTERY</p> <p>INVERTER BATTERY INPUT CANNOT CONNECT TO INCOMPATIBLE BATTERIES.</p>	 <p>Back-Up On-Grid</p> <p>BACK-UP SIDE CANNOT CONNECT TO GRID</p>

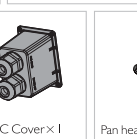
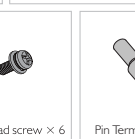
2.2 PACKING LIST

On receiving the inverter, please check to make sure all the components as below are not missing or broken.

 <p>Inverter×1</p>	 <p>Wall-mounted Bracket×1</p>	 <p>Smart Meter x1 with 3 CT</p>	 <p>Positive PV Plug×2or3</p>	 <p>Negative PV Plug×2or3</p>	 <p>Positive BAT Plug×1</p>	 <p>Negative BAT Plug×1</p>
 <p>PE terminal × 1</p>	 <p>Expansion Bolts × 4</p>	 <p>AC Cover × 1</p>	 <p>Pan head screw × 6</p>	 <p>Pin Terminal × 12</p>	 <p>User Manual×1</p>	 <p>Quick Installation Guide×1</p>

2.3 MOUNTING

2.3.1 SELECT MOUNTING LOCATION

For inverter's protection and convenient maintenance, mounting location for inverter should be selected carefully based on the following rules:

Any part of this system shouldn't block the switch and breaker to disconnected Inverter from DC and AC power.

Rule 1. Inverter should be installed on a solid surface, where is suitable for inverter's dimensions and weight.

Rule 2. Inverter installation should stand vertically or lie on a slop by max 15° (Pic 1)

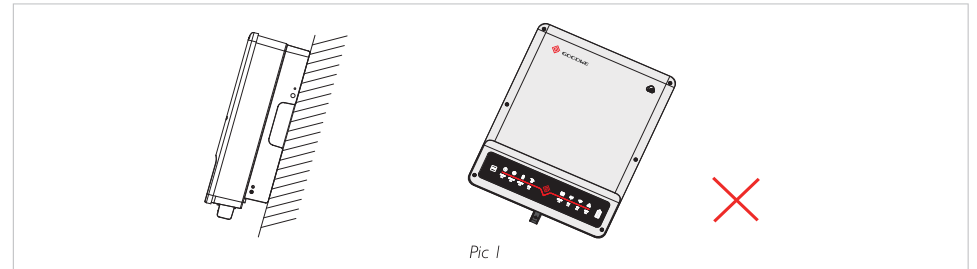

Rule 3. Ambient temperature should be lower than 45°C (High ambient temperature will cause power derating of inverter.)

Rule 4. The installation of inverter should be protected under shelter from direct sunlight or bad weather like snow, rain, lightning etc. (Pic 2)

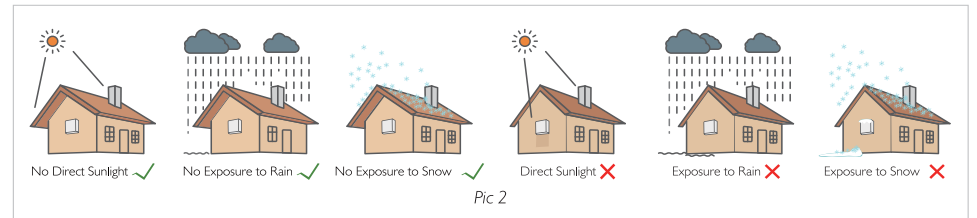

Rule 5. Inverter should be installed at eye level for convenient maintenance.

Rule 6. Product label on inverter should be clearly visible after installation.

Rule 7. Leave enough space around inverter following the values on pic 3.

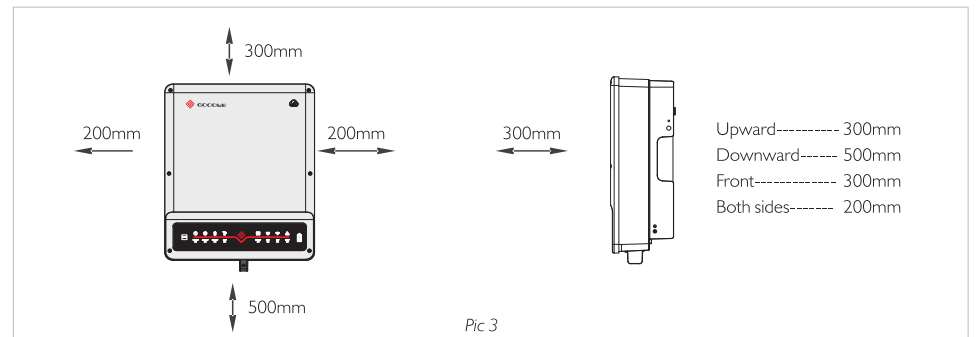

 Inverter cannot be installed near flammable, explosive or strong electro-magnetic equipment.^[1]

2.3.2 MOUNTING

! Remember that this inverter is heavy! Please be careful when lifting out from the package.^[2]

The inverter is suitable for mounting on concrete or other non-combustible surface only

Step 1

- Please use the mounting bracket as a template to drill 4 holes on right positions (10mm in diameter, and 80mm in depth) (Pic 4)
- Use expansion bolts in accessory box and fix the mounting bracket onto the wall tightly

NOTE: Bearing capacity of the wall must be higher than 25 KG, otherwise may not be able to keep inverter from dropping.

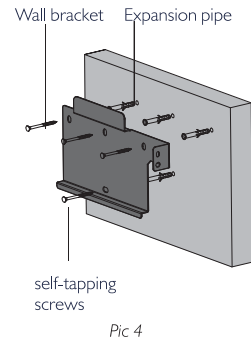

07

Step 2

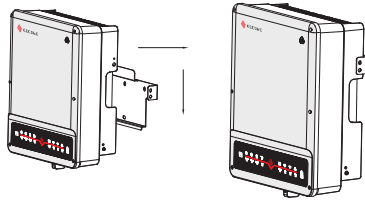

Carry the inverter by holding the heating sink on two sides and Place the inverter on the mounting bracket. (Pic 5)

NOTE: Make sure the heat sink on inverter is rightly joint with mounting bracket.

Step 3

Ground cable shall be connected to ground plate on grid side (Pic 6)

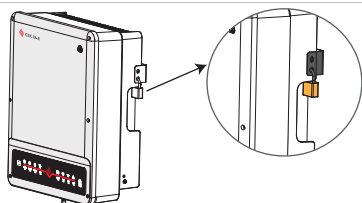
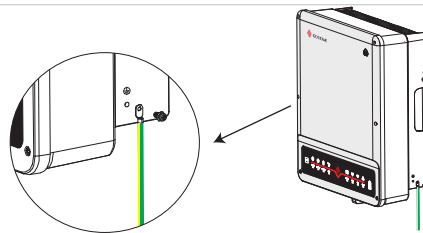

Step 4

A lock could be used for anti-theft if it is necessary for individual requirement. (Pic 7)

2.4 ELECTRICAL WIRING CONNECTION

2.4.1 PV CONNECTION

Before connecting PV panels/strings to inverter, please make sure requirements are followed as below :

- The total short-circuit current of PV string must not exceed inverter's max DC current.
(For GW8KL-ET and GW10KL-ET model, PV2 have 2 pair PV connectors which can accept 2 PV string with total short-circuit current not exceed 22A.)
- The minimum isolation resistance to ground of the PV string must exceed **33.33 kΩ** in case of any shock hazard
- PV strings could not connect to earth/grounding conductor
- Use the right PV plugs in the accessory box
(BAT plugs are similar with PV plugs, please confirm before use it.)

NOTE: There will be MC4 or QC4.10 or Amphenol plugs in accessory box, the detailed connection as below:

Step 1

Prepare PV cables and PV plugs (Pic 8)

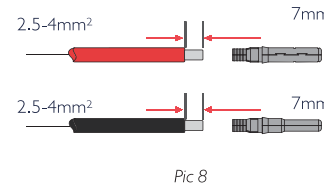

NOTE:

- Please use pv plugs and connectors in GoodWe accessory box
- PV cable should be standard, 2.5-4mm² PV cable

Step 2

Connect PV cable to PV connectors (Pic 9)

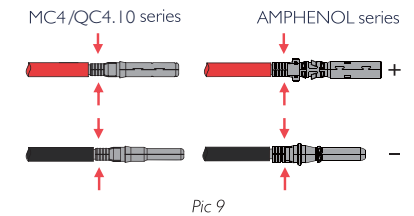

NOTE:

- PV cable must be tightly crimped into the connectors
- For Amphenol connector, the limit buckle cannot be pressed
- There will be a click sound if connectors are inset correctly into PV plugs

08

Step 3

Screw the cap on and plug onto inverter side (Pic 10)

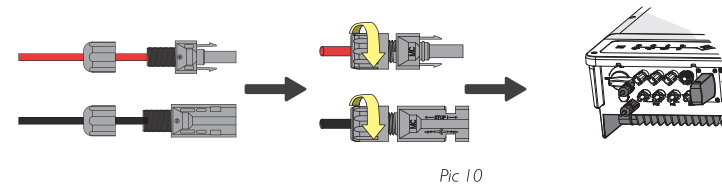

NOTE:

- There will be a click sound if connectors are inset correctly into PV plugs



The polarity of PV strings or on the inverter cannot be connected reversedly , otherwise inverter could be damaged.^[3]

For GW8KL-ET and GW10KL-ET model, use two separate PV plugs if the short current is higher than 15A of the PV array which connect to inverter's PV2 input.

2.4.2 BATTERY CONNECTION

- Please be careful against any electric shock or chemical hazard
- Make sure there is an external DC breaker(≥ 40 A) connected for battery without build-in DC breaker

Make sure battery switch is off and battery nominal voltage meet ET series' specification before connecting battery to inverter and make sure inverter is totally isolated from PV and AC power.^[4]

 Please following requirements and step bellow strictly. Use improper wire may cause bad contact and high impedance, which is dangerous to the system.

- Use the right BAT plugs in the accessory box.
- Use the tin-plated cables with a conductor cross section of 4 to 6 mm² (AWG 10) because the maximum battery current is 25A. Battery cable requirements are as (Pic 11).

Grade	Description	Value
A	Outside diameter insulation	5.5-8.0 mm
B	Conductor core section	4-6 mm ²
C	Conductor core length	15 mm

09

Battery wiring connection steps as below:

Step 1

Open the spring using a screwdriver (Pic12)

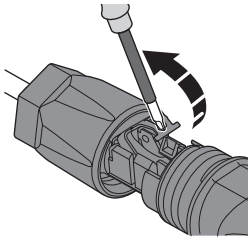

Pic 12

Step 2

Carefully insert the stripped wire with twisted litz wires all the way in (A). The litz wire ends have to be visible in the spring. Close the spring. Make sure that the spring is snapped in (B).

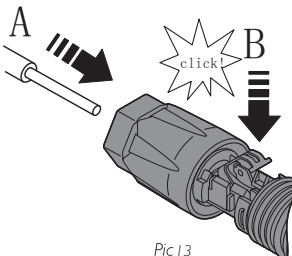

Pic 13

Step 3

Push the insert into the sleeve (C). Tighten the cable gland to 2 Nm (D). Use a suitable and calibrated torque wrench, size 15. Use an open-jaw wrench, size 16, to hold the connector in place.

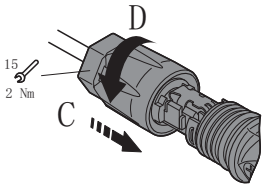

Pic 14

Step 4

Fit the two connectors together until the connection audibly locks into place. Check to make sure the connection is securely locked.

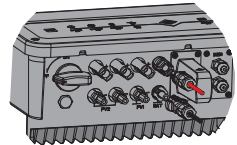

* For the compatible lithium batteries (Pylon/BYD) connection, please refer to battery connection part in ETQUICK INSTALLATION INSTRUCTIONS.

2.4.3 ON-GRID & BACK-UP CONNECTION

An external AC breaker is needed for on-grid connection to isolate from grid when necessary. Below are the requirements on AC breaker:

Inverter model	AC breaker specification
GW5KL/6KL-ET	25A/400V(e.g.DZ47-60 C25)
GW8KL/10KL-ET	32A/400V(e.g.DZ47-60 C32)
GW5K-ET	25A/400V(e.g.DZ47-60 C25)
GW8K/10K-ET	32A/400V(e.g.DZ47-60 C32)

Note: The absence of AC breaker on Back-Up side will lead to inverter damage if only electrical short-circuit happend on Back-Up side.

1. Use separate AC breaker for individual inverter (Pic 15)

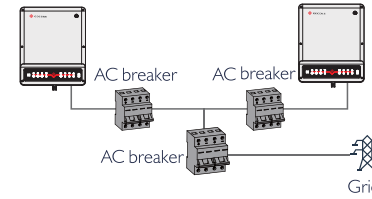

Pic 15

2. On AC side, the individual breaker should be connected before loads (between inverter and loads) (Pic 16)

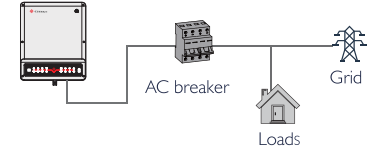

Pic 16

10

- Requirement of AC cable connected to On-Grid and Back-Up side (Pic 17):

 Make sure inverter is totally isolated from any DC or AC power before connecting AC cable^[5]

NOTE:

1. Neutral cable shall be blue, line cable black or brown (preferred) and protective earth cable yellow-green.
2. For AC cables, PE cable shall be longer than N & L cables, so that if in any case AC cable slips or taken out, the protecting earth conductor will be the last to take the strain

Step 1

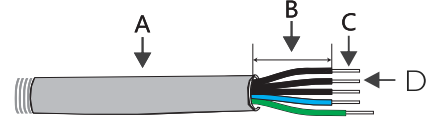

Pic 17

Grade	Description	Value
A	Outside Diameter	13-18mm
B	Separated wire length	20-25mm
C	Conduct wire length	7-9mm
D	Conduct core section	4-6mm ²

Prepare the terminals and AC cables according to the left table

Step 2

Put AC cable through terminal cover follow the sequence as on the left (pic 18)

Note: Please use the terminals in GoodWe components box

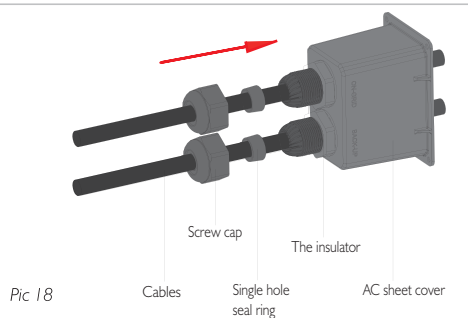

Step 3

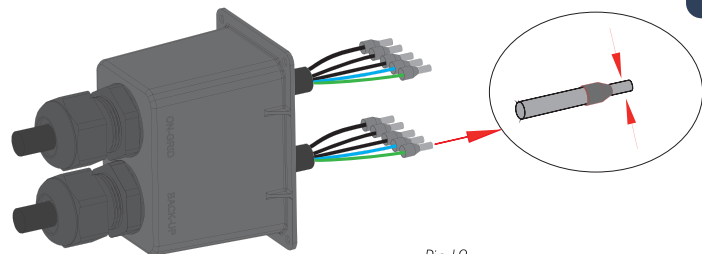

Press the IO connectors on cable conductor core tightly (pic 19)

Note: Make sure cable jacket is not locked within the connector

Step 4

Screwing torque
2.0-2.5N.m

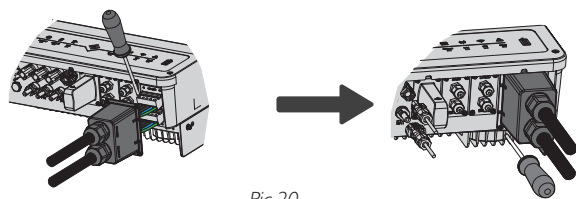

1. Connect the assembled AC cables into AC terminals with fastening torque about 2.0-2.5N.m

Note: Connecting Back-up terminals before connect On-grid terminals

Make sure it is not connected to a wrong side

2. Lock the cover and screw the cap on (pic20)

Special Adjustable Settings

The inverter has field adjustable setting like tripping point, tripping time, reconnect time, active and invalid of QU/PU curves etc. by special firmware. Please contact GoodWe after-sales for the special firmware and adjust methods.

Declaration For Back-Up Loads

ET series hybrid inverters are able to supply over load output power at its' back-up. For details please refer to the technical parameters of ET series inverter(4.3 section) And the inverter has self-protection derating at high ambient temperature.

Accepted loads as below:

- Inductive Load: 1.5P non-frequency conversion air-conditioner can be connect to back-up side. Two or more non-frequency conversion air-conditioner connect to back-up side may cause UPS mode unstable.
- Capacitive Load: Total power $\leq 0.6 \times$ nominal power of model.
Note: Don't connect 3-phase inductive load(like Motor) without Neutral wire. (Any load with high inrush current at start-up is not accepted)
- For complicated application, please contact GoodWe's after service.

Note:

For a convenient maintenance, Please installed a "4 Pole 3 Throw" switch on Back-Up and On-Grid side. Then it is adjustable to support load by Back-Up or by grid or just leave it there (Pic 21)

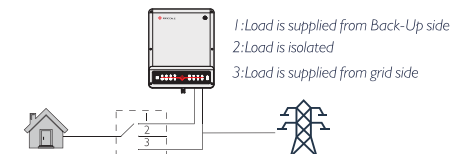

Declaration For Back-Up Overload Protection

Inverter will restart itself as overload protection happens. The preparation time for restarting will be longer and longer (max one hour) if overload protection repeats. Take following steps to restart inverter immediately:

- Decrease Back-Up load power within max limitation
- On PV Master →Advanced Setting →Click "Reset Back-Up Overload History"

2.4.4 SMARTMETER & CT CONNECTION

! Make sure AC cable is totally isolated from AC power before connecting SmartMeter and CT⁽⁶⁾

The SmartMeter with CT in GoodWe product box is compulsory for ET system installation, used to detect grid voltage and current direction and magnitude, further to instruct the operation condition of ET inverter via RS485 communication.

NOTE:

1. The Meter and CT is well configured, please do not change any setting on Meter;
2. One Smart Meter can only be used for one ET inverter.
3. Three CTs must be used for one Smart Meter, and must be connected on the same phase with Smart Meter power cable.

• Smart Meter & CT Connection Diagram (Pic 22)

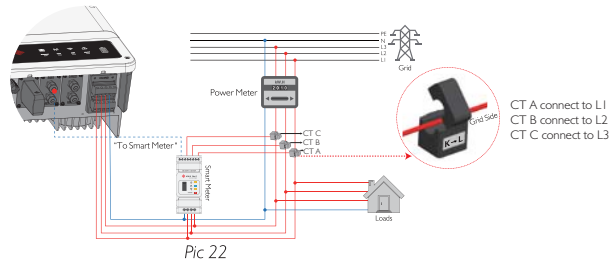

NOTE:

1. Please use the Smart Meter with 3 CTs in GoodWe product box.
2. CT cable is 3m as default, could be extended to max 5m
3. Smart Meter communication cable (RJ45) is attached on the inverter ("To Smart Meter" cable), could be extended to max 100m, and must use standard RJ45 cable and plug, as below:



Position	Color	BMS Function	Smart Meter Function	RS485
1	Orange&white	485_A2	NC	485_A
2	Orange	NC	NC	485_B
3	Green&white	485_B2	485_B1	485_A
4	Blue	CAN_H	NC	NC
5	Blue&white	CAN_L	NC	NC
6	Green	NC	485_AI	485_B
7	Brown&white	NC	485_B1	NC
8	Brown	NC	485_AI	NC

• Smart Meter LED Indications

	OFF	ON	Blinking
POWER	Not working	Working	/
ENERGY	/	Importing	Exporting
COM	Blink one time when it transfer data to inverter		

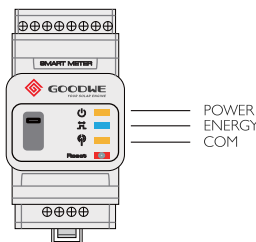

2.5 DRED & EARTH FAULT ALARM

2.5.1 DRED CONNECTION

DRED is only for Australian and New Zealand installations, in compliance with Australian and New Zealand safety requirements. And DRED device is not provided by GoodWe.

Detailed connection of DRED device is shown below:

Step 1

Screw this plate off from inverter (Pic 23)
 Note: DRED device should be connected through "DRED port" as the figure shows.

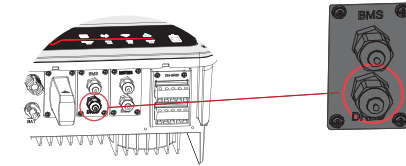

Pic 23

Step 2

1. PLUG OUT the 6-Pin terminal and dismantle the resistor on it (Pic 24)
2. PLUG THE RESISTOR OUT, leave the 6-Pin terminal for next step.

Note: the 6-Pin terminal in the inverter has the same function of DRED device. Please leave it on the inverter if no external device connected.

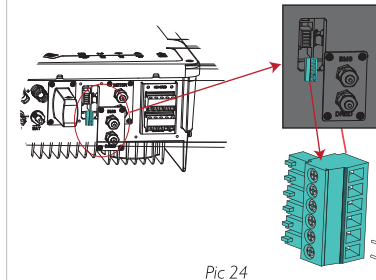

Pic 24

Step 3

1. Put DRED cable through the plate as shown on pic 25
2. Connect DRED cable on the 6-pin terminal.

The function of each connection position as below:

NO	1	2	3	4	5	6
Function	DRM1/5	DRM2/6	DRM3/7	DRM4/8	REFGEN	COM/DRMO

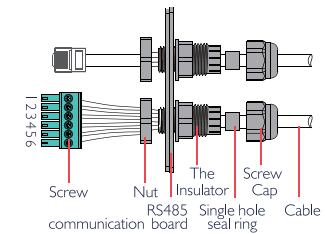

Pic 25

Step 4

Step 4: Connect DRED terminal to the right position onto the inverter (Pic 26)

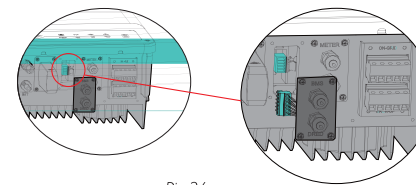

Pic 26

2.5.2 EARTH FAULT ALARM CONNECTION

GoodWe ET series inverter complies with IEC 62109-2 13.9. Fault indicator LED on inverter cover will light up and the system will email the fault information to customer.

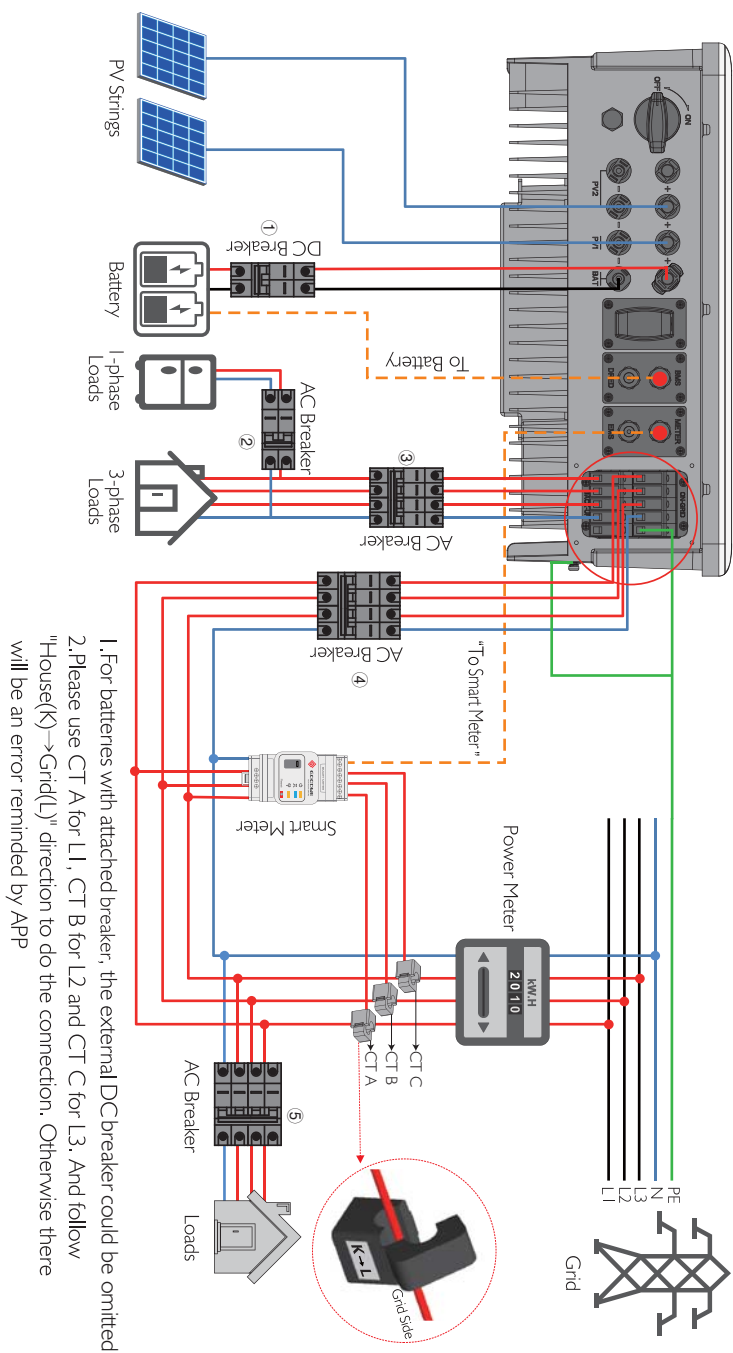

• WIRING SYSTEM FOR ET SERIES HYBRID INVERTER
 Note: This diagram indicated wiring structure of ET series hybrid inverter, not the electric wiring standard.

GW5K/L/6K-L-ET	①	25A/400V AC breaker	④	
GW8K/L/10K-L-ET	②	32A/400V AC breaker	④	
GW5K-ET		25A/400V AC breaker	③	
GW8K/10K-ET		32A/400V AC breaker	③	
	⑤	Depends on household loads		

Please select Breaker according to the specification below

- For batteries with attached breaker, the external DC breaker could be omitted
- Please use CT A for L1, CT B for L2 and CT C for L3. And follow "House(K)→Grid(L)" direction to do the connection. Otherwise there will be an error reminded by APP

• SYSTEM CONNECTION DIAGRAMS

NOTE: For Australian safety country, the neutral cable of On-Grid side and Back-Up side must be connected together, otherwise Back-Up function will not work.

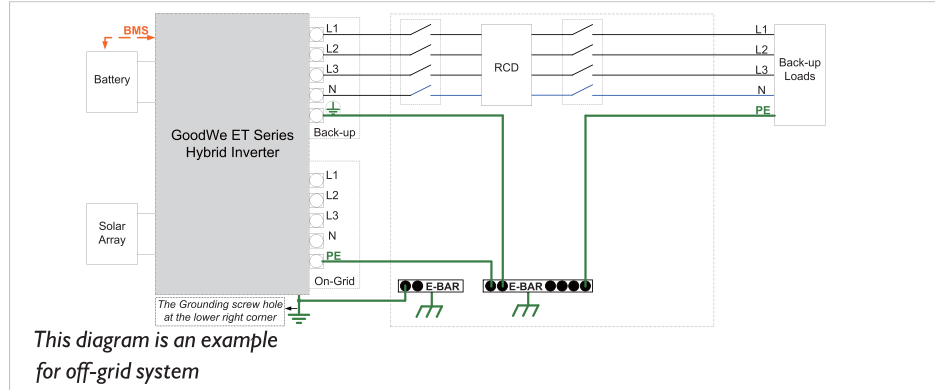
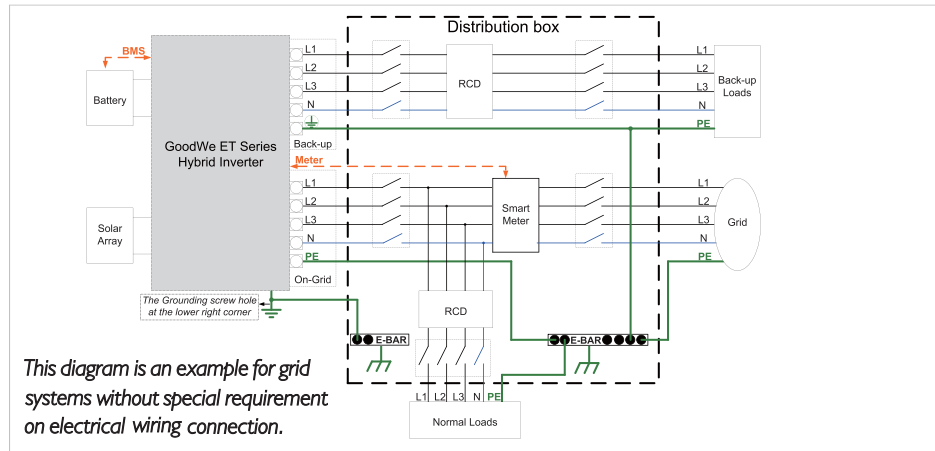
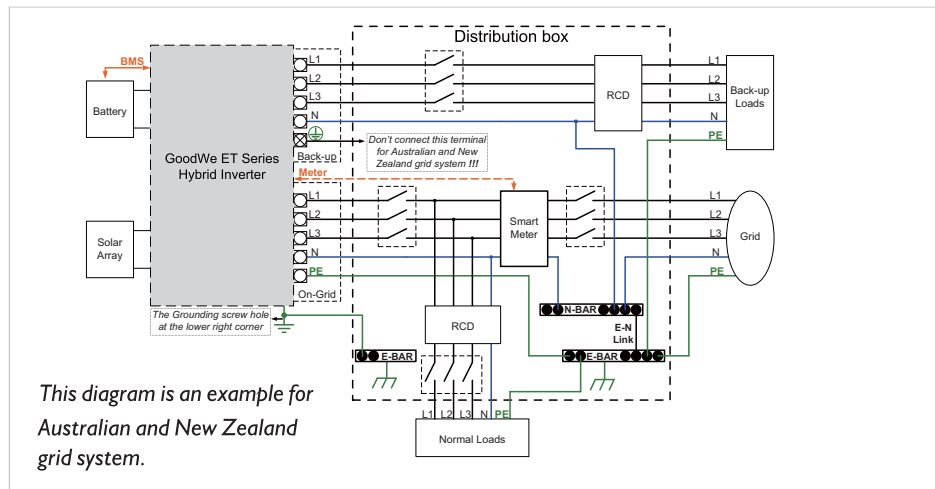

03 MANUAL OPERATION

3.1 WI-FI CONFIGURATION

- This part shows configuration on web page
- Wi-Fi configuration is absolutely necessary for online monitoring and after-sales maintenance

PREPARATION:

1. Inverter must be powered up with only PV power
2. Need a router with available internet access to GoodWe portal www.semsportal.com

Step 1

1. Connect Solar-WiFi* to your PC or smart phone(* means the last 8 characters of the inverter serial No.)
2. Open browser and login 10.10.100.253
Admin (U): admin; Password: admin
3. Then click "OK"

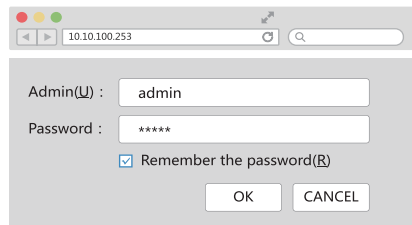

Step 2

1. Click "Start Setup" to choose your router
2. Then click "Next"

Device information	
Firmware version	1.6.9.3.38.2.1.38
MAC address	60:C5:A8:60:33:E1
Wireless AP mode Enable	
SSID	Solar-WiFi
IP address	10.10.100.253
Wireless STA mode Disable	
Router SSID	WiFi_Bum-in
Encryption method	WAP/WAP2-PSK
Encryption algorithm	AES
Router Password	WiFi_Bum-in

Cannot join the network, may be caused by:
router doesn't exist, or signal is too weak, or password is incorrect

★ Help: Wizard will help you to complete setting within one minute.

Start Setup

Please select your current wireless network:

SSID	Sec mode	Enc type	Channel	RSSI
WiFi Test	WAP2-PSK	AES	6	54%

★ Note: When RSSI of the selected WiFi Network is lower than 10%, the connection may be unstable, please select other available network or shorten the distance between the device and the router.
If your wireless router does not broadcast SSID, please click "Next" and add a wireless network manually.

Back **Next**

Step 3

1. Fill in the password of the router, then click "Next"
2. Click "Complete"

Add wireless network manually

Network name (SSID)	WiFi-Test
Encryption method	WPA/WPA2-PSK
Encryption algorithm	AES

Please enter the wireless network password:
Password (8-63 bytes): show psk

Note: case sensitive for SSID and password
Please make sure all parameters of wireless network are matched with router, including password

Back **Next**

Save success!
Click 'Complete', the current configuration will take effect after restart.
If you still need to configure the other pages of information, please go to complete your required configuration.
Configuration is completed, you can log on the Management page to restart device by Click on 'OK' button.

Confirm to complete?
Back **Complete**

- NOTE:
1. Please make sure the password, Encryption Method/Algorithm is right the same with the router's
 2. If everything is right well, the Wi-Fi LED on inverter will change from double blink to quartic blink then to solid status, which means Wi-Fi is connected to GoodWe server successfully.
 3. Wi-Fi configuration could also be done on PV Master, details please check on PV Master APP

• Wi-Fi Reset & Reload

Wi-Fi Reset means restarting Wi-Fi module, Wi-Fi settings will be reprocessed and saved automatically, Wi-Fi Reload means setting Wi-Fi module back to default factory setting.

Wi-Fi RESET Button

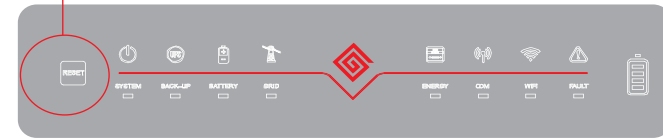

Wi-Fi Reset

short press RESET button
– Wi-Fi Led will blink for a few seconds

Wi-Fi Reload

long press RESET button (longer than 3s)
– Wi-Fi Led on inverter will double blink until doing W-Fi configuration again.

NOTE: Wi-Fi Reset & Reload function are only used when:

1. Wi-Fi lost connection to internet or cannot connect to PV Master App successfully
2. Cannot find "Solar-WiFi signal" or have other Wi-Fi configuration problem
3. Please do not use this button if Wi-Fi monitoring works well

3.2 PV Master APP OPERATION

PV Master is an external monitoring/ configuration application for GoodWe hybrid inverters, used on smart phones or pad for both Android and iOS system, main functions as below:

1. Edit system configuration to make the system work as customer needs
2. Monitor and check performance of the hybrid system
3. Wi-Fi configuration

Please download PV Master OPERATION INSTRUCTIONS from www.goodwe.com



3.3 CEI AUTO-TEST FUNCTION

PV Auto-Test function of CEI is integrated in PV Master App for Italy safety country requirements. For detailed instruction of this function please refer to PV Master OPERATION INSTRUCTIONS

4.1 ERROR MESSAGE AND TROUBLESHOOTINGS

• ERROR MESSAGE

The error messages below will be displayed on PV Master App or report by Email if the error really happen.

ERROR MESSAGE	EXPLANATION	REASON	SOLUTIONS
Utility Phase Failure	The sequence of On-grid wire is wrong	Inverter detects that phase angle of L2 and L3 are reversed	Reverse connection order of L2 and L3 cable
Utility Loss	Not available of public grid power (power lost or on-grid connection fails)	Inverter does not detect the connection of grid	<ol style="list-style-type: none"> 1. Check (use multi-meter) if AC side has voltage , Make sure grid power is available 2. Make sure AC cables are connected tightly and right well 3. If all is well, please try to turn off AC breaker and turn on again after 5 mins
VAC Failure	Grid voltage is not within permissible range	Inverter detects that AC voltage is beyond the normal range required by the safety country	<ol style="list-style-type: none"> 1. Make sure safety country of the inverter is set right 2. Check (use multi-meter) if AC voltage (Between L&N or L&L) is within a normal range (Also on AC breaker side) <ol style="list-style-type: none"> a. if AC voltage is high, then make sure AC cable complies with that required on user manual and AC cable is not too long b. if voltage is low, make sure AC cable is connected well and the jacket of AC cable is not compressed into AC terminal 3. Make sure the grid voltage of your area is stable and within normal range.
FAC Failure	Grid Efficiency is not within permissible range	Inverter detects that Grid frequency is beyond the normal range required by the safety country	<ol style="list-style-type: none"> 1. Make sure safety country of the inverter is set right 2. If safety country is right, then please check on inverter APP if AC frequency (Fac) is within a normal range 3. If FAC failure only appear a few times and resolved soon, it should be caused by occasional grid frequency instability.
PV/BAT Over Vlotage	PV or BAT voltage is too high	The total voltage (open -circuit voltage) of each PV string is higher than the max DC input voltage of the inverter. Or the battery voltage is higher than the max BAT input voltage of the inverter	<p>Check PV string VOC is lower than Max PV Input Voltage of the inverter</p> <p>If VOC of PV string is high, please decrease panels to make sure VOC is with the max DC input voltage of the inverter.</p>
Over Temperature	Temperature inside of the inverter is too high	Inverter working environment leads to a high temperature condition	<ol style="list-style-type: none"> 1. Try to decrease surrounding temperature 2. Make sure the installation complies with the instruction on inverter user manual 3. Try to close inverter for 15 mins, then start up again.
Isolation Failure	Ground insulation impedance of PV string is too low	Isolation failure could be caused by multi reasons like PV panels are not grounded well, DC cable is broken, PV panels are aged or surrounding humidity is comparatively heavy, etc.	<ol style="list-style-type: none"> 1. Use multi meter to check if the resistance between earth & inverter frame is about zero. If it's not, Please make the connection between earth & inverter frame well. 2. If the humidity is very high, there maybe Isolation Failure occur. 3. Check the resistance between PV1 + /PV2+ /BAT + /PV- to earth, if the resistance is lower than 33.3k, check the system wiring connection. 4. Try to restart the inverter, check if the fault is still happens, if not, means it is just an occasional situation, or contact GoodWe.
Ground I Failure	Ground leakage current is over-high	Ground I failure could be caused by multi reasons like neutral cable on AC side is not connected well or surrounding humidity is comparatively heavy, etc.	<p>Check use multi-meter if there is voltage value (normally should be close to 0V) between earth & inverter frame.</p> <p>If there is a voltage, it means the Neutral & ground cable are not connected well on AC side. If it happened only at early morning, dawn or on rainy days with high air humidity, and recover soon, it should be normal</p>
Relay Check Failure	Self checking of relay fails	Neutral & ground cable are not connected well on AC side or just occasional failure	<p>Check use multi-meter if there is high voltage (normally should be lower than 10V) between N&PE cable on AC side.</p> <p>If the voltage higher than 10V, it means the Neutral & ground cable are not connected well on AC side or restart inverter.</p>
DC Injection High	/	Inverter detects a higher DC component in AC output	Try to restart inverter, check if it still happens, if not, means it is just an occasional situation or contact GoodWe
EEPROM R/W Failure	/	Caused by a strong external magnetic field etc.	Try to restart inverter, check if it still happens, if not, means it is just an occasional situation or contact GoodWe
SPI Failure	Internal communication fails	Caused by a strong external magnetic field etc.	Try to restart inverter, check if it still happens, if not, means it is just an occasional situation or contact GoodWe
DC Bus High	BUS voltage is over-high	/	Try to restart inverter, check if it still happens, if not, means it is just an occasional situation or contact GoodWe
Back-Up Over Load	Back-up side is over loaded	Total Back-Up load power is higher than the nominal backup output power	Decrease Back-Up loads to make sure the total load power is lower than Back-Up nominal output power (please refer to page 12)

• TROUBLESHOOTINGS

Checking Before Turning On AC power

- ◆ **Battery Connection:** Confirm the connection between ET and battery : polarity (+/-) not reversed, refer to Pic 28
- ◆ **PV Input Connection:** Confirm the connection between ET and PV panels : polarity (+/-) not reversed, refer to Pic 29
- ◆ **On-Grid & Back-Up Connection:** Confirm ON-GRID connected to power grid and Back-up to loads : polarity (L1/L2/L3/N are in sequence) not reversed, refer to Pic 30
- ◆ **Smart Meter & CT Connection:** Make sure Meter & CT are connected between house loads and grid. and follow the Smart Meter direction sign on CT, refer to Pic 31

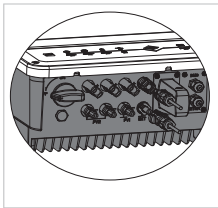

Pic 28

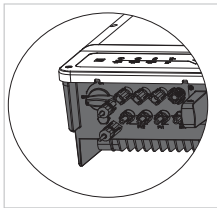

Pic 29

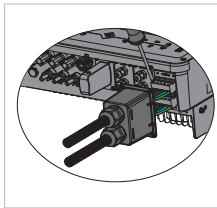

Pic 30

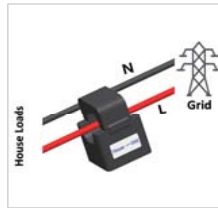

Pic 31

Checking as Start ET up and Turn On AC Power

- ◆ **Battery Settings, BMS Communication and Safety Country:** After connecting Solar-WiFi* (* means the last 8 characters of the inverter serial No.), check on PV Master APP Param to make sure battery type is right what you have installed, and Safety Country is right. If not right, please set it right in "Set" (Pic 33)

NOTE:

For compatible lithium batteries, BMS status is "communication OK" after select the right battery company.

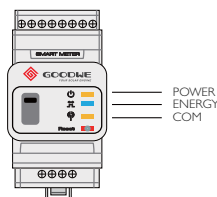

Pic 32



Pic 33

Problems During Operation

ET not Start Up With ONLY Battery

Solution:

1. Make sure the voltage of battery is higher than 180V, otherwise battery cannot start ET up.

ET not Start Up With ONLY PV

Solution:

1. Make sure the voltage of PV is higher than 180V (need 230V to enter on-grid mode).
2. Make sure that connection between ET and PV panels : polarity (+/-) not reversed.

No Discharge or Output From ET at Night Without PV or PV Power Lower Than Load Power:

Solution:

1. Communication between ET and Smart Meter is OK or not
2. Make sure load power is higher than 150W
 - a. battery will not discharge continuously unless load power is higher than 150W
 - b. If battery still not discharge when Smart Meter power is higher than 150W, then please check Smart Meter & CT connection and direction
3. Make sure SOC is higher than 1-DOD. Or if battery discharged to below 1-DOD, than battery will only discharge again when SOC charged to 20%+ (1-DOD) / 2 and SOC > 105% -DOD (if need battery discharge immediately, battery should be restarted)
4. Check on APP if already set charge time, as during charge time, battery will not discharge (battery will charge in priority during coincident time of charge/discharge)

Battery Not Charge When PV Power Higher Than Load Power:

Solution:

1. Check if it is during discharge time set on App
2. Check if battery is fully charged or not, or battery voltage reach "charge voltage" or not

High Power Fluctuation on Battery Charge or Discharge:

Solution:

1. Check if there is a fluctuation on load power
2. Check if there is a fluctuation on PV power

Battery Does Not Charge

Solution:

1. Make sure BMS communication is OK on PV Master
2. Check if CT connected in the right position and to right direction as on the user manual page 13
3. Check if the total load power is much higher than PV power

Questions & Answers (Q & A)

About Wi-Fi Configuration**Q: Why cannot see Solar-WiFi signal on mobile devices**

A: Normally Solar-WiFi signal could be searched right after inverter powered up. But Solar-WiFi signal will disappear when ET connected to internet. If need change settings, can connect to the router to change. If cannot see WiFi signal even not connect to router, then please try to reload WiFi (please refer to ET user manual page 18)

Q: Why cannot connect Solar-Wifi signal on my phone?

A: It is the character of the Wi-Fi module that it can connect to only one device at a time. If the signal is connected to another device at the time for some reason, then you cannot connect to the signal.

About Battery Operation**Q: Why battery does not discharge when grid is not available, while it discharge normally when grid is available?**

A: On APP, Off-Grid Output and backup function should be turned on to make battery discharge under off-grid mode.

Q: Why there is on output on Back-Up side?

A: For Back-Up supply, the "Back-Up Function" on PV Master App must be turned on. Under off-grid mode or grid power is disconnected, "Off-Grid Out" function must be turned on as well

Note: As turn "Off-Grid Output" on, don't restart inverter or battery, otherwise the function will switch off automatically.

Q: On Portal, why battery SOC has a sudden jump up to 95%?

A: This normally happens on when BMS communication fail on lithium battery. If battery enter float charge, SOC will be reset to 95% compulsively.

Q: Why battery cannot be fully charged to 100%

A: Battery will stop charge when battery voltage reaches charge voltage set on PV Master APP

Q: Why battery switch always trip when starts it up (Lithium battery)?

A: The switch of lithium battery normally trips for following reasons:

1. BMS communication fails.
2. Battery SOC is too low, battery trips to protect itself.
3. An electrical short-cut happened on battery connection side. Or other reasons please contact GoodWe for details.

Q: Which battery should I use for ET ?

A: For ET series inverter, it could connect Lithium batteries which have compatibility with ET series inverter. With nominal voltage from 180V to 600V.
Compatible lithium batteries can see on battery list in PV MASTER APP

About PV Master Operation and Monitoring**Q: Why Cannot save settings on PV Master App**

A: This could be caused by losing connection to Solar-WiFi.

1. Make sure you connected Solar-WiFi (make sure no other devices connected) or router (if connected Solar-WiFi to router) and on APP home page shows connection well.

2. Make sure restart inverter 10mins later after you do some setting because inverter will save settings every 10mins under normal mode. We recommend you change setting parameters when inverter under waiting mode.

Q: On the App, why the data on the homepage and Param page is different, like charge/discharge, PV value, load value or grid value?

A: As the data on APP is from inverter and on home page and Param page, the data refresh frequency is different, so there will be a data inconformity between different pages on APP as well as between that on portal and APP

Q: On App, some columns show NA, like battery SOH, etc. why is that?

A: NA means App does not receive data from inverter or server, normally it is because communication problem, such as battery communication, and communication between inverter and the APP.

About Smart Meter and Power Limit Function**Q: How to Act Output Power Limit function?**

A: For ET system, the function could be realized by:

1. Make sure Meter connection and communication well
 2. Turn on Export Power Limit function and Set the max output power to grid on APP
- Note: If Out-put Power Limit set as 0W, then there might still have deviation max 100W exporting to grid.*

Q: Why there is still power exporting to grid after I set power limit as 0W?

A: Export limit could theoretically to minimum 0W, but there will have a deviation of around 50-100W for ET system.

Q: Can I use other brand Meter to take over Smart Meter in ET system or change some settings on Smart Meter?

A: No, because the communication protocol is inset between inverter and Smart Meter, other brand Meter cannot communicate. Also any manual setting change could cause Smart Meter communication failure.

Q: What is the max current allowed going through CT which connected to Smart Meter?

A: The max current for CT is 120A

Other Questions**Q: Is there a quick way to make the system work?**

A: The shortest way, please refer to QUICK INSTALLATION INSTRUCTIONS and PV MASTER APP INSTRUCTION

Q: What kind of load can I connect on Back-Up side?

A: Please refer to user manual on page 12

Q: Whether the warranty of the inverter still valid if the installation or operation does not follow the user manual instructions, for some special conditions when we cannot 100% follow them?

A: Normally if any problem caused by disobey the instructions on user manual, we can provide technical support to help solve the problem, but cannot guarantee a replacement or returns. So if there is any special condition when you cannot 100% follow the instructions, please contact GoodWe for suggestions.

4.2 DISCLAIMER

The ET series hybrid inverters are transported, used and operated under environmental and electrical conditions. GoodWe has the right not providing after-sales services or assistance under following conditions:

- Inverter is damaged during transferring
- Inverter is out of warranty year and extended warranty is not bought
- Inverter is installed, refitted or operated in improper ways without authority from GoodWe
- Inverter is installed or used under improper environment or technical condition mentioned in this user manual, without authority from GoodWe
- Installation or configuration of the inverter does not follow requirements mentioned in this user manual
- The inverter is installed or operated against the requirements or warnings that are mentioned in this user manual
- Inverter is broken or damaged by any force majeure like lightning, earthquake, fire hazard, storm and volcanic eruption etc.
- Inverter is disassembled, changed or updated on software or hardware without authority from GoodWe
- Inverter is installed, used or operated against any related items in international or local policies or regulations
- Any non-compatible batteries, solar panels, loads or other devices connected to ET system

Note: GoodWe will keep right to explain all the contents in this user manual.

* Maintenance

The inverter requires periodically maintenance, details as below:

NOTE: Make sure inverter is totally isolated from all DC and AC power for at least 5 mins before maintenance

Heat sink: please use clean towel to clean up heat sink once a year

Torque: please use torque wrench to tighten AC and battery wiring connection once a year

DC switch: check DC switch regularly, active the DC switch 10 times in a row once a year; operating DC switch will clean contacts and extend lifespan of DC switch

Water-proof covers: check if water-proof covers of RS485 and other part are fasten once a year

4.3 TECHNICAL PARAMETERS AND CERTIFICATES

• TECHNICAL PARAMETERS OF ET INVERTERS

Technical Data	GW5KL-ET	GW6KL-ET	GW8KL-ET	GW10KL-ET	GW5K-ET	GW8K-ET	GW10K-ET
Battery Input Data							
Battery Type	Li-Ion			Li-Ion			
Battery Voltage Range (V)	180~600			180~600			
Max. Charging Current (A)	25			25			
Max. Discharging Current (A)	25			25			
Charging Strategy for Li-Ion Battery	Self-adaption to BMS			Self-adaption to BMS			
PV String Input Data							
Max. DC Input Power (W)	6500	7800	9600	12000	6500	9600	13000
Max. DC Input Voltage (V)*	600			1000			
MPPT Range (V)	200~550			200~850			
Start-up Voltage (V)	180			180			
MPPT Range for Full Load (V)	240~550	285~550	260~550	320~550	240~850	380~850	460~850
Nominal DC Input Voltage (V)	480			620			
Max. Input Current (A)	12.5/12.5		12.5/22		12.5/12.5	12.5/12.5	12.5/12.5
Max. Short Current (A)	15.2/15.2		15.2/27.6		15.2/15.2		
DC overcurrent protection(A)	29.2/29.2		29.2/46.7		29.2/29.2		
PV Backfeed Current(A)	0			0			
No. of MPP Trackers	2			2			
No. of Strings per MPP Tracker	1/1		1/2		1/1		
AC Output Data (On-grid)							
Nominal Apparent Power Output to Utility Grid (VA)	5000	6000	8000	10000	5000	8000	10000
Max. Apparent Power Output to Utility Grid (VA)**	5500	6600	8800	11000	5500	8800	11000
Max. Apparent Power from Utility Grid (VA)	10000	12000	15000		10000	15000	
Nominal Output Voltage (V)	400/380, 3L/N/PE			400/380, 3L/N/PE			
Nominal Output Frequency (Hz)	50/60			50/60			
Max. AC Current Output to Utility Grid (A)	8.5	10.5	13.5	16.5	8.5	13.5	16.5
Max. AC Current From Utility Grid (A)	15.2	18.2	22.7	22.7	15.2	22.7	22.7
Output inrush Current (peak/duration)	220A/5us			220A/5us			
Maximum output RMS overcurrent protection (A)	8.5	10.5	13.5	16.5	8.5	13.5	16.5
AC Backfeed Current@Standby mode (A)	0			0			
Output Power Factor	~1 (Adjustable from 0.8 leading to 0.8 lagging)			~1 (Adjustable from 0.8 leading to 0.8 lagging)			
Output THDi (@Nominal Output)	<3%			<3%			
AC Output Data (Back-up)							
Max. Output Apparent Power (VA)	5000	6000	8000	10000	5000	8000	10000
Peak Output Apparent Power (VA)***	10000, 60sec	12000, 60sec	16000, 60sec	16500, 60sec	10000, 60sec	16000, 60sec	16500, 60sec
Max. Output Current (A)	8.5	10.5	13.5	16.5	8.5	13.5	16.5
Nominal Output Voltage (V)	400/380			400/380			
Nominal Output Frequency (Hz)	50/60			50/60			
Output inrush Current (peak/duration)	50A/2us			50A/2us			
Maximum output RMS overcurrent protection (A)	15.2	18.2	24.2	25.0	15.2	18.2	25.0
Output THDv (@Linear Load)	<3%			<3%			

Technical Data	GW5KL-ET	GW6KL-ET	GW8KL-ET	GW10KL-ET	GW5K-ET	GW8K-ET	GW10K-ET
Protection							
Anti-islanding Protection				Integrated(AFD)			
PV String Input Reverse Polarity Protection				Integrated			
Insulation Resistor Detection				Integrated			
Residual Current Monitoring Unit				Integrated			
Output Over Current Protection				Integrated			
Output Short Protection				Integrated			
Battery Input Reverse Polarity Protection				Integrated			
Output Over Voltage Protection				Integrated			
General Data							
Operating Temperature Range (C)				-35~60			
Relative Humidity				0~95%			
Environment Category				Outdoor & indoor			
External Environment Pollution Degree				Grade I、2、3			
Protective class				Class I			
Over voltage category				DC II: ACIII			
Operating Altitude (m)				≤4000			
Cooling				Nature Convection			
Noise (dB)				<30			
User Interface				LED&APP			
Communication with BMS				RS485; CAN			
Communication with Meter				RS485			
Communication with EMS				VRS485 (Insulated)			
Communication with Portal				Wi-Fi			
Weight (kg)	24			25			24
Size (Width*Height*Depth mm)				516*415*180			
Mounting				Wall Bracket			
Protection Degree				IP65			
Standby Self Consumption (W) ****				<15			
Topology				Transformerless			
Certifications & Standards							
Grid Regulation	AS/NZS 4777.2:2015			CEI 0-21; VDE4105-AR-N; VDE0126-1-1; EN50438; G83/2; G100			
Safety Regulation	IEC62109-1&2, IEC62040-1			IEC62109-1&2, IEC62040-1			
EMC	EN61000-6-1, EN61000-6-2, EN61000-6-3, EN61000-6-4, EN61000A-4-16A, EN61000-4-18, EN61000-4-29						

* For 1000V system, Maximum operating voltage is 950V

** According to the local grid regulation

*** Can be reached only if PV and battery power is enough

**** No Back-up Output

• CERTIFICATES OF ET SERIES



G100 IEC62109-1 CEI 0-21
RD1699 VDE0126-1-1 VDE-AR-N 4105 NRS 097-2-1

• OTHER TEST

For Australian requirements, in the THDI test, there should add Zref between inverter and mains.

RA , XA for Line conductor

RN, XN for Neutral conductor

Zref:

RA=0,24;XA=j0,15 at 50Hz;

RN=0,16;XN=j0,10 at 50Hz.

4.4 WARINING QUICK CHECK LIST

- [1] Inverter cannot be installed near flammable, explosive or strong electro-magnetic equipment, page 06
- [2] Remember that this inverter is heavy! Please be careful when lifting out from the package, page 07
- [3] The polarity of PV strings or on the inverter cannot be connected by reverse, otherwise inverter could be damaged, page 08
- [4] Make sure battery switch is off and battery nominal voltage meet ET specification before connecting battery to inverter and make sure inverter is totally isolated from PV and AC power, page 09
- [5] Make sure inverter is totally isolated from any DC or AC power before connecting AC cable, page 10
- [6] Make sure AC cable is totally isolated from AC power before connecting Meter and CT, page 13

Appendix: Protection Category Definition

Overvoltage Category Definition

Category I	Applies to equipment connected to a circuit where measures have been taken to reduce transient overvoltage to a low level
Category II	Applies to equipment not permanently connected to the installation. Examples are appliances, portables tools and other plug-connected equipment
Category III	Applies to a fixed equipment downstream of and including the main distribution board. Examples are switchgear and other equipment in an industrial installation
Category IV	Applies to equipment permanently connected at the origin of an installation (upstream of the main distribution board). Example are electricity meters, primary over-current protection equipment and other equipment connected directly to outdoor open lines

Moisture Location Category Definition

Moisture Parameters	Level		
	3K3	4K2	4K4H
Temperature Range	0~+40 C	-33~+40 C	-20~+55 C
Humidity Range	5%~85%	15%~100%	4%~100%

Environment Category Definition

Environment Condition	Ambient Temperature	Relative Humidity	Applied to
Outdoor	-20 ~ 50 C	4% ~ 100%	PD3
Indoor Unconditioned	-20 ~ 50 C	5% ~ 95%	PD3
Indoor Conditioned	0 ~ 40 C	5% ~ 85%	PD2

Pollution Degree Definition

Pollution Degree I	No pollution or only dry, non-conductive pollution occurs. The pollution has no influence
Pollution Degree II	Normally only non-conductive pollution occurs. Occasionally, however, a temporary conductivity caused by condensation must be expected.
Pollution Degree III	Conductive pollution occurs, or dry, non-conductive pollution occurs, which becomes conductive due to condensation, which is expected.
Pollution Degree IV	Persistent conductive pollution occurs, for example, the pollution caused by conductive dust, rain and snow.